

Automatic Washing Machine

USER'S MANUAL

PHILCO 

Famous for Quality the World Over

PL 151



**Dear customer,
Thank you for buying a PHILCO brand product. So that your appliance serves you well, please read all
the instructions in this user's manual.**

CONTENTS

PART 1: BEFORE PUTTING INTO OPERATION	2
• Important safety instructions.....	2
• General safety information.....	2
• Recommendations.....	3
PART 2: INSTALLATION	4
• Removal of the transportation screws.....	4
• Levelling the washing machine.....	5
• Electrical connection.....	5
• Water supply connection.....	5
• Water drain connection.....	6
PART 3: CONTROL PANEL	7
• Start/Pause button.....	7
• Individual function indicator lights.....	7
• Function buttons	8
• Spinning speed knob	8
• Program selector.....	9
PART 4: WASHING YOUR LAUNDRY	10
• First wash cycle.....	10
• Before actually washing	10
• Operating the washing machine	11
• Child lock	12
PART 5: MAINTENANCE AND CLEANING	14
• Water inlet filters.....	14
• Pump filter.....	14
• Detergent drawer	15
• Siphon plug	16
• Cabinet of the washing machine	16
• Drum.....	16
• Removal of scale deposits from the washing machine.....	16
PART 6: PRACTICAL INFORMATION	17
PART 7: PREVENTION OF MINOR MALFUNCTIONS	18
PART 8: AUTOMATIC MALFUNCTION DETECTION SYSTEM	21
PART 9: INTERNATIONAL WASHING SYMBOLS	23
PART 10: TECHNICAL SPECIFICATIONS	24
PART 11: ENERGY SAVING TIPS.....	24

PART 1: BEFORE PUTTING INTO OPERATION

Important safety instructions:

- Read carefully and store for future use.
- The safety of this appliance complies with industry norms and meets legal appliance safety requirements. However, as manufacturers, we consider it our duty to provide you with the following safety instructions.
- It is essential that you store this user's manual in a safe place so that you can use it in the future. If you intend to sell the appliance, give it to another owner, or if you move, always make sure that the user's manual is attached to the appliance, so that the new owner can find out about the operation of the appliance and the relevant warnings.
- Before installation or operation of the appliance you **MUST** carefully read all the safety instructions and the user's manual.
- Before putting the appliance into operation for the first time, check that it has not been damaged during transport.
- Never connect a damaged appliance. If some parts are damaged, contact the supplier.
- If the washing machine is supplied in the winter months, when the temperature falls under 0°C, store the appliance at room temperature for 24 hours before first use.

General safety instructions

- Changing the technical parameters, or any making other modifications to the appliance is dangerous.
- During the course of the high temperature program the door heats up to a high temperature. Do not touch the door!
- Ensure that small household pets cannot get into the drum. It is therefore better to always check the inside of the drum before use.
- Items such as coins, safety pins, nails, bolts, stones and other heavy or sharp items can cause considerable damage and do not belong in the appliance.
- Use only the recommended amount of fabric softener and washing detergents. If you use a higher amount than is recommended, the fabric could be damaged.
- Always use the amount of detergent recommended by the manufacturer.
- Small pieces of laundry such as socks, shoelaces, washing bands, etc. should be washed in a special purpose washing bag or in a pillow case, because the individual items could become jammed between the tube and the rotating drum.
- Do not use the washing machine to wash products from metal skeletons, fabrics which are not hemmed or that snag.
- After use, before cleaning or maintenance always disconnect the washing machine from the power supply and turn off the water inlet.
- Never attempt to repair the appliance yourself. Repairs carried out by inexperienced persons may lead to injuries or serious damage to the appliance. Contact your local service centre for repairs. Always request original spare parts.
- Do not use multi-sockets or extension cords.
- Do not plug in the appliance with a defective power cord.
- If the power cord is damaged, have it replaced by the manufacturer or an authorised service technician to prevent hazardous situations.
- Do not pull the power plug out of the power socket by pulling on the cord. Hold the power cord by holding the power plug directly.
- Do not connect the power plug if you have wet hands.

- Never touch the appliance if you have wet hands or feet.
- Never open the detergent drawer while washing.
- Never attempt to open the washing machine door while washing.
- Because the washing machine can become very hot during operation, do not touch the hose during the draining or filling process.
- In the case of any defect, first turn off the appliance, disconnect it from the power supply and shut off the water inlet. Do not attempt to repair the device yourself. Contact the nearest authorised service.
- Do not forget that the packaging material from the washing machine may present a danger to children.
- Do not allow children to play with the washing machine.
- Keep household pets at a safe distance from the washing machine.
- The washing machine should only be used by persons fully instructed about the instructions, provisions and controls described in this user's manual.
- This washing machine is designed for domestic use only. The use of the washing machine for commercial purposes voids the warranty.
- Do not install the appliance on a carpet or another similar surface, which could block the ventilation openings on the underside.
- Do not place the drain hose into a container, bucket or sink.

Recommendation

- Long term contact of washing detergents and fabric softeners with air will cause them to dry out and stick to the walls of the drawer. To prevent this from happening, fill the drawer with washing detergent and fabric softener immediately before washing.
- We recommend the use of the prewash only for heavily soiled laundry.
- Do not exceed the maximum loading capacity of the drum.
- This appliance must not be used by persons (including children) with physical, sensory or psychological impairments or by inexperienced persons, unless properly trained or schooled in the safe use of the appliance, or unless they have been properly supervised by a person who will be responsible for their safety. Children should be supervised so as not to play with the appliance.
- If you will not be using the washing machine for an extended period of time, pull it out of the power socket, shut off the water inlet and leave the door open so that the inside of the washing machine can dry out and so unpleasant odours are not created.
- As a result of quality control procedures some water may remain in the washing machine. This will not damage the washing machine in any way.
- We recommend that the first wash is performed using the White 90-95° program (depending on the model) without any laundry, put 1/2 a measuring cup of detergent into the second detergent compartment.

PART 2: INSTALLATION

Carefully read the entire user's manual before putting your washing machine into operation and store it in a safe place for future reference.

Removal of the transportation screws

- You must remove the transportation screws located in the back part of the washing machine before putting it into operation.
- Loosen the bolts using a correctly sized spanner, turning it anticlockwise. (PIC. 1)
- Remove the bolts by pulling them out. (PIC. 2)
- Insert plastic plugs found in the accessories pouch, into the transportation screw openings. (PIC. 3)
- Carefully store the transportation screws removed from the washing machine for future transport purposes.

NOTE:

Defects caused by starting the washing machine with the transportation screws installed are not covered by the warranty.

PIC. 1



PIC. 2

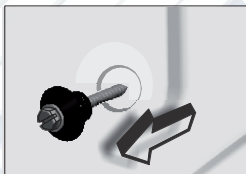

PIC. 3

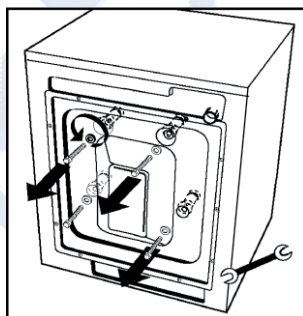

Levelling the washing machine

- Do not place the washing machine on carpets or similar surfaces.
- To ensure quite and vibration free operation of your washing machine, you should place it on an even, non-slip and firm surface.

You can level the washing machine by adjusting the adjustable feet:

- First loosen the plastic nut.
- Adjust by screwing out the feet upwards or downwards.
- After levelling the washing machine, re-tighten the plastic nut by screwing it upwards.
- Never level the washing machine on an uneven surface by placing cardboard, wooden blocks, etc. under the feet.

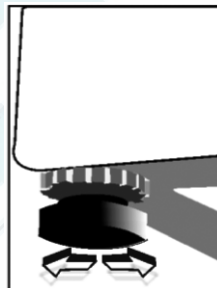
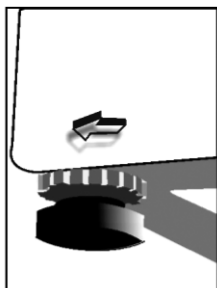

Electrical connection

- Technical specifications of your washing machine: 220-240 V ~ 50 Hz.
- A special grounding plug is attached to the power cord of your washing machine. This plug must be fully inserted into a grounded power socket (with 10 A). The electrical fuse or circuit breaker to which the washing machine is connected should be rated at 10A. If you do not have such sockets and fuses in your home, have them installed by a qualified electrician.
- Our company takes no responsibility for whatever damages caused by using the washing machine without grounding.

Water supply connection

- Your machine has a single water (cold) inlet.
- To prevent from the leakages on the connection joints, 1 seal is included in the hose packing. (Fit this seal on the end of the water inlet hose at the tap side.)
- Connect the end with bracket of the water inlet hose to the water inlet valve at the rear of the machine and the other end to your tap. In case you are not assured, let a qualified plumber make the connection works.
- The water pressure of 0.1 - 1 MPa in your water tap will ensure a more efficient operation of your washing machine (the pressure of 0.1 MPa equates to a flow rate of more than 8 litres of water per minute from a fully open tap).

- After the connections are complete, check that the connections do not leak, by fully opening the tap.
- Check that the supply hoses are not bent, broken or cracked.
- Connect the supply hose to a 3/4" threaded water tap.

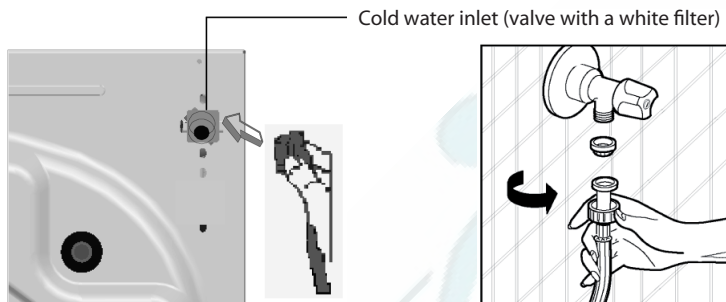

Water drain connection

- Check that the supply hoses are not bent, twisted, cracked or excessively stretched.
- The drain hose should be installed at a height of min. 60 cm and max. 100 cm above the ground.
- The end of the drain hose may be inserted directly into the drain opening or to a special end fitting attached to the drain of the wash basin.
- Never attempt to extend the length of the drain hose by adding extra parts.

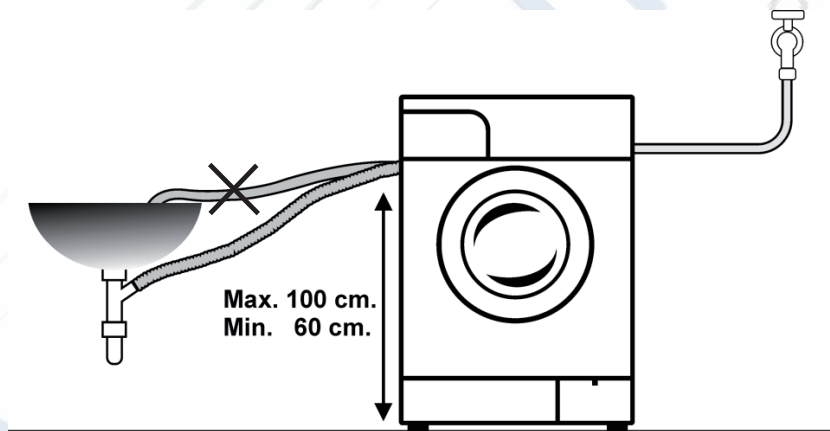
**NOTE:**

Do not place the drain hose into a container, bucket or sink.

PART 3: CONTROL PANEL

Control panel

(3 buttons, adjustable thermostat)

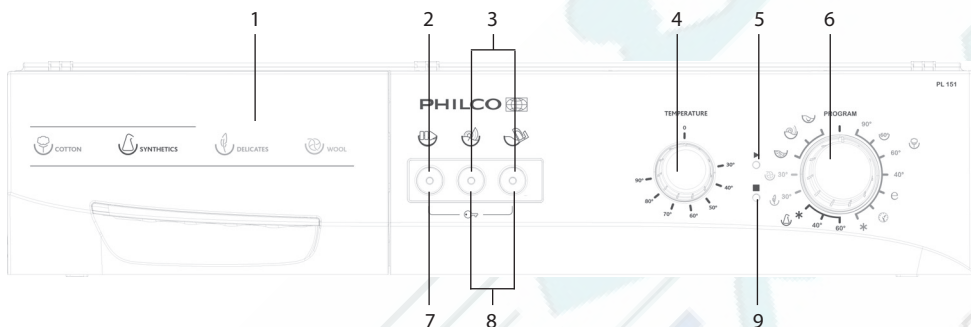

- | | |
|--------------------------------|-----------------------|
| 1. Detergent drawer | 6. Program knob |
| 2. Start/pause light | 7. Start/pause button |
| 3. Function indicator lights | 8. Function buttons |
| 4. Temperature adjustment knob | 9. Program end light |
| 5. Program ready light | |

Our product has electronic card and soft-touch buttons. To activate the functions touch the buttons slightly.

START/PAUSE Button

Intended for starting the selected program or to pause the program that is running.



WARNING!

Before selecting the desired program or changing a program, you must have the program selector turned to the O position (off).

Individual function indicator lights

If you press any function button or the Start/pause button, the respective indicator light will turn on. The indicator light will turn off if you press any other function button or the Start/pause button or at the completion of the selected function.

The function indicator lights are also used for the troubleshooting system, see chapter 8.

Function buttons

No spin

This program is recommended to be used for your sensitive clothes on which no spinning should be done. By pressing this function button, you can cancel the spinning process which is included in the program.

Easy ironing

By using this function, you can ensure your clothes to come out less wrinkled after the washing.

**WARNING!**

If you forget to set an additional function and the washing machine has already started washing, press the additional function button. If its indicator light turns on, the additional function has been activated. If its indicator light does not turn on, the additional function has not been activated.

Temperature adjustment knob

By the temperature adjustment knob, you can adjust the washing water temperature of your clothes between 0 (cold wash) and 90°C. When you are selecting the washing water temperature, pay attention to the international washing signs on your clothes.

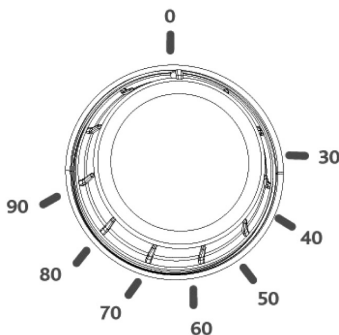
**NOTE:**

Carry out the spinning of your delicate laundry using the most appropriate mode.

Program selector

Using the program selector, select a program, in which you wish to wash your laundry. The program selection may be done by turning the program selector knob in both directions. When making settings, ensure that the symbol on the program selector exactly matches your selected washing program. If you turn the program selector to the 0 position (off) during the wash, the program will remain unchanged.

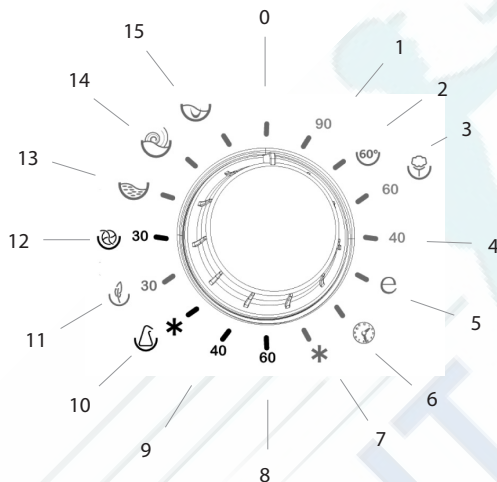

- | | |
|-----------------------------|--------------------|
| 1. COTTON 90°C | 9. SYNTHETIC 40°C |
| 2. COTTON 60°C WITH PREWASH | 10. SYNTHETIC COLD |
| 3. COTTON 60°C | 11. DELICATE 30°C |
| 4. COTTON 40°C | 12. WOOL 30°C |
| 5. ECO WASH | 13. RINSING |
| 6. QUICK WASH | 14. SPIN |
| 7. COTTON COLD | 15. DRAINING |
| 8. SYNTHETIC 60°C | 0. OFF |

	Max. Spinning rpm
COTTON 90°C	1000
COTTON 60°C PREWASH	1000
COTTON 60°C	1000
COTTON 40°C	1000
ECO WASH	1000
QUICK WASH	800
COTTON COLD	1000
SYNTHETIC 60°C	800
SYNTHETIC 40°C	800
SYNTHETIC COLD	800
DELICATE 30°C	560
WOOL 30°C	560
RINSING	800
SPINNING	800
OFF	-

	Total time (min)
COTTON 90°C	155
COTTON 60°C PRW	140
COTTON 60°C	190
COTTON 40°C	180
ECO WASH	80
QUICK WASH	30
COTTON COLD	110
SYNTHETICS 60°C	84
SYNTHETICS 40°C	65
SYNTHETICS COLD	72
DELICATE 30°C	70
WOOL 30°C	73
RINSE	28
SPIN	10
DRAIN	2

PART 4: WASHING LAUNDRY

- Connect the washing machine to the power socket.
- Open the water tap.

First wash cycle

There may be some water left over inside the washing machine from the factory tests. We therefore recommend to perform the first wash without laundry so as to drain this water; put half a measure of standard detergent into compartment 2, which is used for washing detergents and select the program for cotton at 90 °C.

Before actually washing

Sorting laundry

- Sort the laundry according to its type (cotton, synthetics, delicates, wool, etc.), washing temperature and the level of dirtiness.
- Never wash whites together with coloured laundry.
- Because your new coloured laundry may release some of its colour, wash it separately.
- Before placing the laundry into the washing machine check pockets for any forgotten items. In this way you will prevent damaging your clothes and the washing machine.
- Do up zips and buttons on the laundry.
- From curtains and drapes remove the plastic or metal hooks or insert the into a wash bag and tie it up.
- Turn clothing such as pants, knitted fabrics, T-shirts and singlets inside out.
- Wash small items such as socks and handkerchiefs in a wash bag.



Placing clothing inside the washing machine

- Open the door of the washing machine.
- Spread the laundry evenly inside the washing machine.
- Insert one item at a time.
- When closing the door, make sure that no laundry has been caught in the door.
- Firmly close the washing machine door, otherwise the washing machine will not start.

Detergent dosage

The amount of detergent you use in the washing machine depends on the following criteria:

- The consumption of detergent changes with the degree of dirtiness of the laundry. Do not use a prewash for lightly soiled laundry and use a small amount of detergent in compartment 2 for washing detergents.
- For excessively soiled laundry select a program with a prewash, put ¼ of a detergent measuring cup into compartment 1 for washing detergents and put the remainder of the measuring cup into compartment 2.
- Use washing detergents specially made for automatic washing machines. The dosage of the detergent is shown on the packaging.
- Increased water hardness necessitates the use of an increased amount of detergent in the wash.

- Increases laundry amounts also necessitate the use of an increased amount of detergent in the wash.
- Pour fabric softeners (conditioners) into the fabric softener compartment in the detergent drawer. Do not go over the MAX mark. Otherwise the fabric softener will flow out the siphon into the water used for washing.
- If the fabric softener is very thick then dilute it with water before placing it in the compartment. The thick fabric softener could clog up your siphon and so prevent the fabric softener from entering the washing machine.
- You can use liquid detergents for all washing programs without a prewash. For this purpose install into the second detergent compartment in the drawer a measuring cup and pour in the detergent according to the mark shown on the measuring cup.

Operating the washing machine

Selecting programs and functions

Select a program and additional functions appropriate for your laundry according to table 1.

Start/pause button

Press this button to start the selected program or to stop a currently running program.

Starting a program

- Set the program selector to the desired program.
- The program indicator light will turn on.
- If necessary you may select one or more additional functions.
- Start the selected program by pressing the Start/pause button.

Changing a program

If you have selected a program and you do not wish it to run to its completion:

- Press the Start/pause button.
- Turn the program selector by turning it to O (off).
- Set the program selector to the desired program. (you may select a program according to table 1.)
- The program indicator light will turn on.
- Start the selected program by pressing the Start/pause button.

Cancelling a program

If you want to stop a program that is running sooner:

- Press the Start/pause button.
- Turn the program selector by turning it to O (off).
- Turn the program selector to the drain or spinning program.
- The program indicator light will turn on.
- Start the selected program by pressing the Start/pause button.

Ending a program

- After the completion of a selected program the washing machine will automatically stop.
- The end of program indicator light will turn on.
- Turn the program selector by turning it to O (off).

- The door will unblock itself about two minutes after the end of the program. Open the door by pulling on the door handle towards yourself and take the laundry out of the washing machine.
- After taking the laundry out of the washing machine, leave the door open so that the washing machine can dry out.
- Disconnect the washing machine from the power socket.
- Shut off the water inlet.

**WARNING!**

If at any washing stage the washing machine is turned off and then on again, the washing machine will activated the program in the place where it was interrupted. This will not damage the washing machine in any way.

Child safety lock

The child safety lock is designed to prevent a program from being changed by a button being pressed during a wash. The child lock is activated by simultaneously pressing the first and third function buttons on the control panel and holding them down for at least 3 seconds. After it has been activated the LED indicator lights will flash on the function buttons indicating that the child lock is on. Deactivate the child lock by pressing the same buttons (the first and third) and holding them down for at least 3 seconds. The LED indicator light on the Start/pause button will flash to indicate that the lock has been turned off.

**WARNING!**

After the child lock is turned on the washing machine will disable the program selector, spinning speed knob and the function buttons.

Table 1

PROGRAM	DETERGENT COMPART.	MAX DRY LOAD CAPACITY (kg)	TYPE OF LAUNDRY	EXPLANATIONS
1-COTTON 90°	2	5	Dirty, boil, cotton and linen textile	Underwears, sheet, table cloth, t-shirt, shirt, towel
2-COTTON 60° (PREWASH)	1+2	5	Very dirty, cotton, coloured and linen textile	
**3-COTTON 60°	2	5	Dirty, cotton, coloured and linen textile	
4-COTTON 40°	2	5	Slightly dirty, paint to get out, cotton, coloured and linen textile	
5-ECO WASH	2	5	Dirty, cotton, coloured and linen textile	
6-QUICK WASH	2	2,5	Slightly dirty, cotton, coloured and linen textile	Nylon socks, blouse
7-COTTON COLD	2	5	Slightly dirty cotton, coloured and linen textile. Washed without heating the tap water.	
8-SYNTHETIC 60°	2	3	Dirty, synthetic or synthetic mixture textile	
9-SYNTHETIC 40°	2	3	Slightly dirty, synthetic or synthetic mixture textile	Nylon socks, blouse
10-SYNTHETIC COLD	2	3	Slightly dirty, synthetic or synthetic mixture sensitive laundry. Washed without heating the tap water.	Nylon socks, blouse
11-DELICATE 30°	2	2	Slightly dirty, cotton, coloured, synthetic or synthetic mixture sensitive laundry	Silk mixture, shirt, blouse, polyester, poliamid, mixture textile
12-WOOL 30°	2	2	Dirty, hand and machine to wash wool laundry	All wool laundry
13-RINSING	When you need an additional rinsing to be done to your clothes after the washing process, you can use this program for all kinds of clothes.			
14-SPINNING	When you need an additional spinning to be done to your clothes after the washing process, you can use this program for all kinds of clothes.			
15-DRAINING	This program is used to drain the dirty water inside after the washing process of your machine. If you want the water inside your machine to be drained before the program ends, you can use this program.			

(*) You can use softeners in all programs (except spinning and draining programs) optionally. When you arrange the quantity of the softener, comply with the warning of the softener producer. Fill your softener in its (softener) compartment of the detergent drawer.

** Energy label data based on programme tested in accordance with EN60456.

NOTE:

(*) Softeners (conditioners) can be used for all programs (except for spinning and draining). When selecting a softener dose follow the instructions of the softener's manufacturer. Pour the fabric softener into the softener compartment in the detergent drawer.

PART 5: MAINTENANCE AND CLEANING



- Disconnect the washing machine from the power socket.
- Shut off the water inlet.

The water inlet filters

There are filters connected to the hose ends at the tap end and at the end of the inlet valves, which prevent dirt and foreign materials contained in water entering the washing machine. If the washing machine is not filling up with a sufficient amount of water despite the water inlet being open, clean these filters.

- Disconnect the supply hose.
- Using tweezers take the filters out of the inlet valves and wash them with a brush.
- Using your hand take out the filters on the supply hoses at the end connected to the tap together with the seals and clean them.
- After cleaning the filters put them back in the same way.

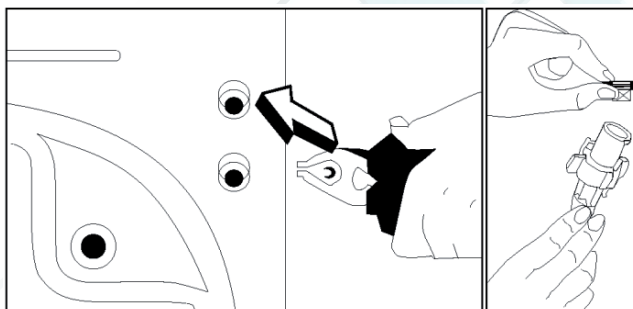
**Attention:**

The water inlet valves may be blocked by a contaminated water supply or because of inadequate necessary maintenance, or the valves may be damaged, which may cause a water to constantly flow through. For these reasons such types of malfunctions are not covered by the warranty.

The pump filter

The pump filtration system extends the life of the pump, which is used for draining dirty water. It ensures that lint from the laundry does not enter the pump. We recommend you clean the pump filter every 2-3 months. Clean the pump filter as follows:

- Open the cover on the kickplate.
- Before opening the filter cover, place a container in front of it, into which the water remaining in the washing machine will flow.
- Loosen the filter cover by turning it anticlockwise and drain the water.
- Remove all foreign material from the filter.
- Check by hand that the pump rotates.
- After cleaning the pump, return the filter by turning it clockwise.

- Reattach the kickplate cover.
- Don't forget that if you do not attach it correctly, water will leak from your washing machine.

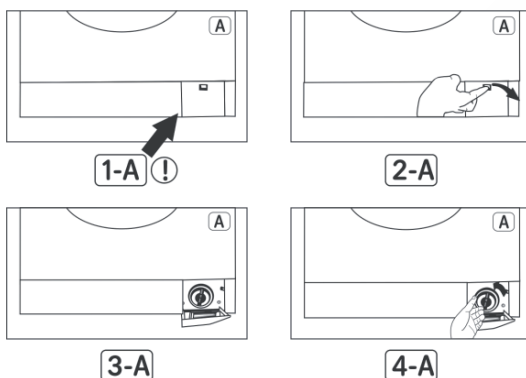
**WARNING!****Danger of scalding!****Because the water in the pump may be very hot, wait until it has cooled down.**

The drawer for washing detergents

Over time washing detergent deposits may accumulate in the drawer and in the washing machine opening. Therefore, the washing detergent drawer needs to be regularly cleaned from accumulated deposits. Take the drawer out as follows:

- Pull the drawer out completely (PIC. 1).
- Fully press down the lid of the siphon inside the drawer and pull the drawer until you pull it out (PIC. 2).
- Wash with water and an old toothbrush.
- Remove the deposits accumulated inside the drawer opening without them being allowed to enter the washing machine.
- Once the drawer is dry, insert it back into the washing machine in the reverse sequence here described.

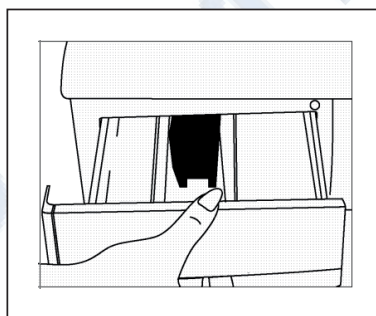

PIC. 1

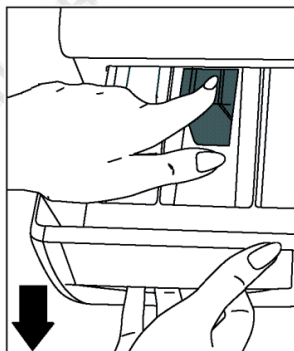

PIC. 2

Siphon plug

Take out the washing detergent drawer. Pull out the siphon plug and thoroughly clean off fabric softener residue. Reinsert the cleaned siphon plug in its place. Check that it is properly inserted.

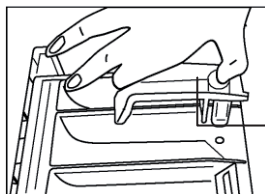

Siphon plug

The washing machine cabinet

Clean the washing machine from the outside using lukewarm water and a gentle cleaning agent, which will not damage the surface coat of the washing machine cabinet. After rinsing with clean water, wipe the washing machine with a soft and dry wiping cloth.



WARNING!

If you have installed the washing machine in a place where the ambient temperature falls below 0°C and you will not be using it, do the following:

- *Connect the washing machine to a power socket.*
- *Close the water tap and disconnect the supply hose or hoses.*
- *Insert the end of the drain hose and supply hose into a container on the ground.*
- *Set to program selector to the drain program.*
- *The program indicator light will turn on.*
- *Start the program by pressing the Start/pause button.*
- *After the program has finished (the end indicator light will turn on) disconnect the washing machine from the power socket.*

After completing these steps the remaining water in the washing machine will be drained, which will avoid the danger of it freezing inside the washing machine. If you wish to use the washing machine again, ensure that the ambient temperature is above 0°C.

The Drum

Do not leave any metal items inside the washing machine, such as needles, clips or coins, etc. These items can cause rusty stains to appear on the drum. If you wish to remove these stains, use a cleaning agent not containing chloride and follow the instructions of the cleaning agent's manufacturer. Never use steel wool used for dishes, or any other similar abrasive items to clean the rusty stains.

Removal of scale deposits from the washing machine

We recommend the use of a commonly available scale remover and to follow the instructions printed on the packaging.



WARNING!

Scale removal mixes contain acids and may cause discolouration of your laundry and may have a negative effect on your washing machine.

PART 6: PRACTICAL INFORMATION



Alcoholic beverages: First prewash the stain in cold water, then apply glycerine and water and rinse in a solution of water and vinegar.



Shoe polish: First lightly scrub the stain without damaging the fabric using washing detergent and rinse. If the stain does not go away, apply a solution of one part pure alcohol (96 percent) and two parts water and subsequently wash in lukewarm water water.



Tea and coffee: Stretch the part of the laundry with the stain over the top of a pot and rinse with water that is as hot as the fabric will handle. If it is appropriate for your laundry, wash the stain in bleaching lye.



Chocolate and cocoa: Leave your laundry in cold water and scrub with soap or washing detergent, then wash in water that is as hot as the fabric will handle. If an oily stain remains on your laundry, wash in hydrogen peroxide (concentration 3%).



Ketchup: After scratching away dried residues without damaging the laundry, leave to soak for about 30 minutes in cold water and wash with a washing detergent.



Bouillon, eggs: Remove dried residues and wipe with a sponge or a soft wiping cloth dipped in cold water. Apply washing detergent and wash in diluted lye.



Greasy and oily stains: First wipe away residues. Apply washing powder to the stain and then wash in lukewarm water soapy water.



Mustard: First apply glycerine to the stain. Apply washing powder and then wash. If the stain does not disappear, apply alcohol to the stain (for synthetics and coloured laundry use a solution of 1 part alcohol and 2 parts water)



Blood: Leave your laundry to soak in cold water for 30 minutes. If the stain does not disappear, dip into a solution of water and ammonia (3 spoons of ammonia per 4 litres of water) for about 30 minutes.



Cream, ice cream and milk: Leave your laundry in cold water and apply washing detergent to the stain. If the stain does not disappear, apply lye to it in the correct concentration for the given type of fabric (do not use lye on coloured laundry).



Soil: Remove soil stains as soon as possible. Wash in washing detergent and if it does not disappear, apply oxygenated water (concentration 3%).



Ink: Dip the stain in cold water and wait until the ink dissolves in the water. Then apply water with lemon juice a washing detergent to the stain, wait about 5 minutes and then wash.



Fruit: Stretch the part of the laundry with the stain over the top of a pot and pour cold water on it. Pour hot water on to the stain. Apply cold water and glycerine. Wait 1-2 hours and sprinkle with white vinegar, then rinse.



Grass stains: Apply washing detergent to the stain. If it is appropriate for this type laundry, wash the stain in lye. To woollen clothing apply alcohol. (For coloured clothing us a solution of 1 part pure alcohol and 2 parts water).



Oil paints: You should remove the stains before they dry using a solvent. Then apply a washing detergent and wash.



Scorch stains: If your laundry will allow it, you can put lye into the washing water. For woollen laundry you should cover the stain with a wiping cloth dipped in oxygenated water, place a dry wiping cloth over this and iron over the stain. After rinsing you should thoroughly was the laundry.

PART 7: PREVENTION OF MINOR MALFUNCTIONS

All necessary repairs of the washing machine should be performed by an authorised service centre. If it is necessary to repair your washing machine or you are unable to remedy the malfunction using the information below:

- Disconnect the washing machine from the power socket.
- Shut off the water inlet.
- Contact the nearest authorised service.

MALFUNCTION	POSSIBLE CAUSE	REMEDY
Your washing machine is not working.	It is not connected to a power socket.	Connect the power plug to the power socket.
	The fuse has burnt out.	Replace the fuse.
	A power outage occurred.	Check whether the electricity is working.
	You didn't press the Start/pause button.	Press the Start/pause button.
	The program selector is in the position O (off).	Turn the program selector to the desired position.
	The washing machine door is not properly shut.	Close the door properly. You should hear it click in.
Your washing machine is not filling up with water.	The water inlet is shut off.	Open the water inlet.
	The supply hose may be bent.	Check the supply hose.
	The supply hose is clogged.	Clean the supply hose filters. (*)
	The inlet valve filter is clogged.	Clean the inlet valve filters. (*)
	The washing machine door is not properly shut.	Close the door properly. You should hear it click in.
Your washing machine is not draining water.	The drain hose is clogged or bent.	Check the drain hose.
	The pump filter is clogged.	Clean out the pump filter. (*)
	You didn't place the laundry evenly into the washing machine.	Arrange the laundry inside the washing machine so that it is evenly arranged in the drum.
The washing machine is vibrating.	A foot of the washing machine hasn't been adjusted.	Adjust the foot. (**)
	You didn't remove the transporting screws.	Remove the transporting screws. (**)

(*) See chapter referring to cleaning and maintenance.

(**) See chapter referring to the installation of your washing machine.

MALFUNCTION	POSSIBLE CAUSE	REMEDY
The washing machine is vibrating.	There is not very much laundry in the washing machine.	This doesn't prevent the operation of the washing machine.
	There is an excessive amount of laundry in the washing machine or the laundry is not arranged evenly.	Do not exceed the recommended laundry amount and arrange it evenly inside the drum.
	The washing machine is touching a rigid object.	Ensure that the washing machine is not touching any rigid objects.
There is an excessive amount of foam in the drawer for washing detergent.	You have used too much washing detergent.	Press the Start/pause button. To prevent the formation of foam, pour one spoon of softener into half a litre of water and pour this solution into the drawer for the washing detergent. After 5 - 10 minutes press the Start/pause button. Next time you wash select the correct washing detergent dosage.
	You have used an inappropriate washing detergent.	Use only washing detergent intended for automatic washing machines.
The results of the wash are not satisfactory.	Your laundry is too dirty for the selected program.	Select a more appropriate program. (see Table 1)
	You have not used enough washing detergent.	Use more washing detergent, depending on its properties.

MALFUNCTION	POSSIBLE CAUSE	REMEDY
The results of the wash are not satisfactory.	You have placed too much laundry in the washing machine.	Only place as much laundry into the washing machine as not to exceed the maximum capacity of the washing machine.
	Maybe you have hard water.	Use as much washing detergent so as to meet the instructions of the washing detergent's manufacturer.
	The laundry is not evenly arranged inside the washing machine.	Arrange the laundry inside the washing machine so that it is evenly arranged in the drum.
The water is drained out of the washing machine immediately after it has been filled.	The end of the drain hose is too low relative to the washing machine.	Locate the drain hose at an appropriate height. (**)
No water can be seen in the drum during the wash.	This is not a malfunction. The water is in the lower part of the drum.	-
There are washing detergent residues on the laundry.	Insoluble residues of the washing detergent in the form of white stains may appear on the laundry.	Set the calibration of your rinsing program on your washing machine to an additional rinse or after the laundry has dried remove the stains using a brush.
There are grey stains on the laundry.	These stains may be caused by oil, a cream or a lotion.	During the next wash use the maximum amount of washing detergent set by its manufacturer.
Spinning does not take place or it is very late.	This is not a malfunction. In this way the test of the unbalanced load may working.	The uneven contents testing system may be trying to use a homogeneous method to evenly arrange the laundry in the drum. After it has been arranged the washing machine will go to the spinning process. For the next wash, place the laundry arranged evenly into the drum.

(**) See chapter referring to the installation of your washing machine.

PART 8: AUTOMATIC MALFUNCTION DETECTION SYSTEM

Your washing machine is equipped with a system, which during the washing process continually monitors the correct progress and in the case of any malfunction takes the necessary remedy measures and will at the same time inform you about the malfunction.





MALFUNCTION CODE	MALFUNCTION INDICATION	POSSIBLE CAUSE	POSSIBLE REMEDY
Err 01	The Start/pause button is flashing.	The washing machine door is not properly shut.	Close the door properly until you hear a click. If the problem continues, turn off the washing machine disconnect it from the power socket and immediately contact the nearest authorised service centre.





MALFUNCTION CODE	MALFUNCTION INDICATION	POSSIBLE CAUSE	POSSIBLE REMEDY
Err 02	Activation of program indicator light is flashing.	The water level in the washing machine is under the heating element. Maybe the water supply pressure is low or blocked.	Fully open the water inlet. Maybe the municipal water supply has been interrupted, check it. If the problem persists, the washing machine will turn itself off after a while. Disconnect it from the power socket, shut off the water inlet and contact your nearest authorised service centre.
Err 03	The Start/pause and program activation indicator light is flashing.	A pump malfunction or the pump filter is clogged.	Clean out the pump filter. If the problem persists, contact your nearest authorised service centre. (*)
Err 04	The program end light blinks .	Communication error	Shut down your machine and unplug. Turn off your tap and apply to the nearest authorized service.





(*) See chapter referring to cleaning and maintenance.



MALFUNCTION CODE	MALFUNCTION INDICATION	POSSIBLE CAUSE	POSSIBLE REMEDY
Err 05	The Start/pause and the end of program indicator light is flashing.	Malfunction of the washing machine heating element or the heating sensor.	Turn off the washing machine and disconnect it from the power socket. Shut off the water inlet and contact your nearest authorised service centre.
Err 06	The program activation and end of program are flashing.	Malfunction of the motor.	Turn off the washing machine and disconnect it from the power socket. Shut off the water inlet and contact your nearest authorised service centre.
Err 07	The Start/pause, program activation and the end of program indicator light is on.	Configuration error.	Turn off the washing machine and disconnect it from the power socket. Shut off the water inlet and contact your nearest authorised service centre.
Err 08	The Start/pause, program activation and the end of program indicator light is flashing.	Malfunction of the motor.	Turn off the washing machine and disconnect it from the power socket. Shut off the water inlet and contact your nearest authorised service centre.
Err 09	The program activation and the end of program indicator light is on.	The voltage in the mains is too high or too low.	If the voltage in the mains is lower than 150 V or higher than 260 V, the washing machine will stop automatically. After the voltage in the mains returns to normal the washing machine will continue in the process.

PART 9: INTERNATIONAL WASHING SYMBOLS

			
Washing temperature	Do not wash (hand wash)	Lukewarm iron	Medium hot iron

			
Hot iron	Do not iron	Do not tumble dry	Hang to dry

			
Drip dry.	Dry flat	Do not bleach	May be bleached.

		
<p>These are symbols for dry cleaning. The letters instruct the cleaner on the type of agent to use. Garments bearing these symbols should not be washed in a washing machine, unless the label says otherwise.</p>		

PART 10: TECHNICAL SPECIFICATIONS

Operating voltage / frequency (V/Hz)	220 - 240 V ~ 50 Hz
Total current (A)	10
Water pressure (MPa)	Max.: 1 MPa Min.: 0.1 MPa
Total power input (W)	2100
Max. dry laundry capacity (kg)	5
Spinning (rpm)	Max. 1000
Number of programs	15
Dimensions (height x width x depth) (cm)	85 x 60 x 50
Noise level during washing / spinning (dB)	58/77

Note: All the here mentioned data is subject to change.

PART 11: ENERGY SAVING TIPS

Energy and water consumption may vary depending on the water pressure, water hardness, water temperature, ambient temperature, amount of laundry, selection of additional functions, voltage fluctuations.

You will limit energy and water consumption if during the use of your washing machine you adhere to the capacity stated for a given program, you wash laundry that is less soiled or daily using shorter programs, if you regularly clean it and carry out maintenance on it, if you use it during the night time off-peak currents set by your electricity supplier.

INSTRUCTIONS AND INFORMATION REGARDING THE DISPOSAL OF USED PACKAGING MATERIALS

Dispose of packaging material at a public waste disposal site.

DISPOSAL OF USED ELECTRICAL AND ELECTRONIC APPLIANCES



The meaning of the symbol on the product, its accessory or packaging indicates that this product shall not be treated as household waste. Please, dispose of this product at your applicable collection point for the recycling of electrical & electronic equipment waste. Alternatively in some states of the European Union or other European states you may return your products to your local retailer when buying an equivalent new product. The correct disposal of this product will help save valuable natural resources and help in preventing the potential negative impact on the environment and human health, which could be caused as a result of improper liquidation of waste. Please ask your local authorities or the nearest waste collection centre for further details. The improper disposal of this type of waste may fall subject to national regulations for fines.

For business entities in the European Union

If you wish to dispose of an electrical or electronic device, request the necessary information from your seller or supplier.

Disposal in other countries outside the European Union

If you wish to dispose of this product, request the necessary information about the correct disposal method from local government departments or from your seller.



This product meets all the basic EU regulation requirements that relate to it.

Changes to the text, design and technical specifications may occur without prior notice and we reserve the right to make these changes.

